



Model: SWR05ED

Normal Duty Walk-In Oven

LEWCO Normal-Duty Batch Ovens are designed for common applications, such as pre-heating, drying, and baking. These models offer quality and performance at economical prices. Heavy-duty construction and industry standard components yield durable and reliable equipment. The SWR series features a rear mounted heater box, which is ideal for installations with height restrictions. Each unit is fully assembled, wired, and tested prior to shipment. All LEWCO ovens are manufactured to meet the requirements of NFPA 86.

Operating Temperature

- 200°F - 500°F (93°C -260°C)

Heating Source & Capacity

- Electric, low watt density Incoloy® heaters provide years of trouble free service.
- Standard heater bank assemblies are installed in high velocity ductwork to maximize heat transfer.

Airflow Pattern

- Dual Airflow: Hot air is supplied from both of the side walls and returned through a top plenum.

General Construction

- 16 ga. aluminized steel interior
- 18 ga. cold rolled steel exterior
- Heat loss is minimized by a unique wall design featuring a welded inner shell and a completely isolated outer frame and covers.

Finish

- Blue or gray alkyd enamel
- Optional: Premium finish for corrosive environments

Doors

- Heavy-duty doors on an isolated door frame minimize heat loss. Wire core gaskets create a tight seal for efficient heating.
- Explosion venting latches
- Standard: Bi-parting swing doors
- Optional:
 - Vertical lift guillotine door
 - Door windows

Floor

- Standard: 12 ga. plate floor
- Optional:
 - 12 ga. plate floor with (1) pair inverted angle track
 - 12 ga. plate floor with (1) pair 6" wide wheel guides
 - Insulated (100 p.s.f. max.)
 - Insulated with (1) pair inverted angle track
 - Insulated with (1) pair 6" wide wheel guides
 - No floor

Input Voltage

- Standard 480/3/60
- Please consult factory for other available options.

Controls

- Single set-point temperature controller and redundant high-limit controller
- NEMA 12 enclosure with full voltage lockable disconnect switch
- Circulation fan(s) include air proving circuits that are electrically interlocked with the heating circuit.
- Controls are wired to NFPA 70 and 79 electrical standards, and meet the requirements of NFPA 86, Class B ovens.
- Optional:
 - Door Switch
 - Batch Timer
 - Ramp/ Soak controller
 - Data logger/ chart recorder
 - Zero speed switch for fans
 - Composite curing controls

Quality Assurance

- Each unit comes complete with a (1) year warranty and is fully assembled, wired, and tested prior to shipment.
- Unit manufactured under ISO 9001 Quality Certified System.



Industrial Batch Ovens

Model: SWR05ED

Model (NFPA Class B)	Overall Dimensions			Door Swing Radius	Workspace Dimensions			Workspace Volume (cubic ft.)	Heater Bank (kW)	Circulating Fan (CFM)	Motor (HP)	Air Changes per Minute	Exhaust Fan Capacity (CFM)	Exhaust Motor (HP)	Solvents per Batch (Gals.)	Ships Fully Assembled
	"W	"D	"H		"W	"D	"H									
SWR05ED-48-48-60	77	106	72	24	48	48	60	80	36	1,000	1	12.50	N/A	N/A	0	Yes
SWR05ED-48-48-72	77	106	84	24	48	48	72	96	36	1,400	1	14.58	N/A	N/A	0	Yes
SWR05ED-48-48-96	79	106	108	24	48	48	96	128	45	1,700	1	13.28	N/A	N/A	0	Yes
SWR05ED-48-72-72	79	130	84	24	48	72	72	144	45	1,700	1	11.81	N/A	N/A	0	Yes
SWR05ED-48-72-96	83	130	108	24	48	72	96	192	54	2,500	2	13.02	N/A	N/A	0	Yes
SWR05ED-48-96-72	83	154	84	24	48	96	72	192	54	2,500	2	13.02	N/A	N/A	0	Yes
SWR05ED-48-96-96	83	158	108	24	48	96	96	256	63	3,000	2	11.72	N/A	N/A	0	Yes
SWR05ED-60-60-60	89	118	72	30	60	60	60	125	36	1,400	1	11.20	N/A	N/A	0	Yes
SWR05ED-60-60-72	91	118	84	30	60	60	72	150	45	1,700	1	11.33	N/A	N/A	0	Yes
SWR05ED-60-60-96	95	118	108	30	60	60	96	200	54	2,500	2	12.50	N/A	N/A	0	Yes
SWR05ED-60-72-72	95	130	84	30	60	72	72	180	45	2,500	2	13.88	N/A	N/A	0	Yes
SWR05ED-60-72-96	95	134	108	30	60	72	96	240	54	3,000	2	12.50	N/A	N/A	0	Yes
SWR05ED-60-96-96	97	164	108	30	60	96	96	320	63	4,000	3	12.50	N/A	N/A	0	Yes
SWR05ED-72-72-72	107	130	84	36	72	72	72	216	54	2,500	2	11.57	N/A	N/A	0	Yes
SWR05ED-72-72-96	109	134	108	36	72	72	96	288	63	3,500	3	12.15	N/A	N/A	0	Yes
SWR05ED-72-96-96	111	168	108	36	72	96	96	384	72	4,500	3	11.72	N/A	N/A	0	Yes
SWR05ED-72-120-96	113	198	108	36	72	120	96	480	81	5,500	3	11.46	N/A	N/A	0	Yes
SWR05ED-84-84-84	121	152	96	42	84	84	84	343	63	4,000	3	11.66	N/A	N/A	0	Yes
SWR05ED-84-96-84	123	168	96	42	84	96	84	392	72	4,500	3	11.48	N/A	N/A	0	Yes
SWR05ED-84-120-84	125	198	96	42	84	120	84	490	81	5,500	3	11.22	N/A	N/A	0	Yes
SWR05ED-84-120-96	129	198	108	42	84	120	96	560	90	7,000	5	12.50	N/A	N/A	0	Yes
SWR05ED-96-96-96	139	174	108	48	96	96	96	512	81	6,000	3	11.72	N/A	N/A	0	Yes
SWR05ED-96-120-96	145	198	108	48	96	120	96	640	99	8,000	5	12.50	N/A	N/A	0	Yes
SWR05ED-96-144-96	149	222	108	48	96	144	96	768	108	9,000	7 1/2	11.72	N/A	N/A	0	Yes
SWR05ED-96-168-96	153	258	108	48	96	168	96	896	126	12,000	7 1/2	13.39	N/A	N/A	0	Yes
SWR05ED-120-120-96	173	198	108	60	120	120	96	800	108	9,000	7 1/2	11.25	N/A	N/A	0	Yes
SWR05ED-120-120-120	177	210	132	60	120	120	120	1,000	135	12,000	7 1/2	12.00	N/A	N/A	0	Yes
SWR05ED-120-144-96	177	234	108	60	120	144	96	960	135	12,000	7 1/2	12.50	N/A	N/A	0	Yes
SWR05ED-120-144-120	183	234	132	60	120	144	120	1,200	144	14,000	10	11.66	N/A	N/A	0	Yes
SWR05ED-120-168-96	183	258	108	60	120	168	96	1,120	144	14,000	10	12.50	N/A	N/A	0	Yes
SWR05ED-120-168-120	185	267	132	60	120	168	120	1,400	162	16,000	10	11.43	N/A	N/A	0	Yes

NOTE: Sizes are approximate. LEWCO, Inc. reserves the right to change specifications without notice.



Industrial Batch Ovens

Model: SWR05ED

Model (NFPA Class A)	Overall Dimensions			Door Swing Radius	Workspace Dimensions			Workspace Volume (cubic ft.)	Heater Bank (kW)	Circulating Fan (CFM)	Motor (HP)	Air Changes per Minute	Exhaust Fan Capacity (CFM)	Exhaust Motor (HP)	Solvents per Batch (Gals.)	Ships Fully Assembled
	"W	"D	"H		"W	"D	"H									
SWR05ED-48-48-60	77	106	123	24	48	48	60	80	45	1,000	1	12.50	62	1/4	0.05	Yes
SWR05ED-48-48-72	77	106	135	24	48	48	72	96	45	1,400	1	14.58	62	1/4	0.05	Yes
SWR05ED-48-48-96	79	106	159	24	48	48	96	128	54	1,700	1	13.28	62	1/4	0.05	Yes
SWR05ED-48-72-72	79	130	135	24	48	72	72	144	54	1,700	1	11.81	62	1/4	0.05	Yes
SWR05ED-48-72-96	83	130	159	24	48	72	96	192	54	2,500	2	13.02	62	1/4	0.05	Yes
SWR05ED-48-96-72	83	154	135	24	48	96	72	192	54	2,500	2	13.02	62	1/4	0.05	Yes
SWR05ED-48-96-96	83	158	159	24	48	96	96	256	63	3,000	2	11.72	62	1/4	0.05	Yes
SWR05ED-60-60-60	89	118	123	30	60	60	60	125	45	1,400	1	11.20	62	1/4	0.05	Yes
SWR05ED-60-60-72	91	118	135	30	60	60	72	150	54	1,700	1	11.33	62	1/4	0.05	Yes
SWR05ED-60-60-96	95	118	159	30	60	60	96	200	63	2,500	2	12.50	62	1/4	0.05	Yes
SWR05ED-60-72-72	95	130	135	30	60	72	72	180	54	2,500	2	13.89	62	1/4	0.05	Yes
SWR05ED-60-72-96	95	134	159	30	60	72	96	240	63	3,000	2	12.50	62	1/4	0.05	Yes
SWR05ED-60-96-96	97	164	159	30	60	96	96	320	81	4,000	3	12.50	100	1/4	0.08	Yes
SWR05ED-72-72-72	107	130	135	36	72	72	72	216	63	2,500	2	11.57	62	1/4	0.05	Yes
SWR05ED-72-72-96	109	134	159	36	72	72	96	288	72	3,500	3	12.15	62	1/4	0.05	Yes
SWR05ED-72-96-96	111	168	159	36	72	96	96	384	90	4,500	3	11.72	100	1/4	0.08	Yes
SWR05ED-72-120-96	113	198	159	36	72	120	96	480	99	5,500	3	11.46	100	1/4	0.08	Yes
SWR05ED-84-84-84	121	152	147	42	84	84	84	343	90	4,000	3	11.66	100	1/4	0.08	Yes
SWR05ED-84-96-84	123	168	147	42	84	96	84	392	90	4,500	3	11.48	100	1/4	0.08	Yes
SWR05ED-84-120-84	125	198	147	42	84	120	84	490	135	5,500	3	11.22	250	1/4	0.21	Yes
SWR05ED-84-120-96	129	198	159	42	84	120	96	560	135	7,000	5	12.50	250	1/4	0.21	Yes
SWR05ED-96-96-96	139	174	159	48	96	96	96	512	135	6,000	3	11.72	250	1/4	0.21	Yes
SWR05ED-96-120-96	145	198	159	48	96	120	96	640	144	8,000	5	12.50	250	1/4	0.21	Yes
SWR05ED-96-144-96	149	222	159	48	96	144	96	768	153	9,000	7 1/2	11.72	250	1/4	0.21	Yes
SWR05ED-96-168-96	153	258	159	48	96	168	96	896	171	12,000	7 1/2	13.39	250	1/4	0.21	Yes
SWR05ED-120-120-96	173	198	159	60	120	120	96	800	162	9,000	7 1/2	11.25	250	1/4	0.21	Yes
SWR05ED-120-120-120	177	210	183	60	120	120	120	1,000	171	12,000	7 1/2	12.00	250	1/4	0.21	Yes
SWR05ED-120-144-96	177	234	159	60	120	144	96	960	171	12,000	7 1/2	12.50	250	1/4	0.21	Yes
SWR05ED-120-144-120	183	234	183	60	120	144	120	1,200	189	14,000	10	11.66	250	1/4	0.21	Yes
SWR05ED-120-168-96	183	258	159	60	120	168	96	1,120	180	14,000	10	12.50	250	1/4	0.21	Yes
SWR05ED-120-168-120	185	267	183	60	120	168	120	1,400	207	16,000	10	11.43	500	1	0.42	Yes

NOTE: Sizes are approximate. LEWCO, Inc. reserves the right to change specifications without notice.

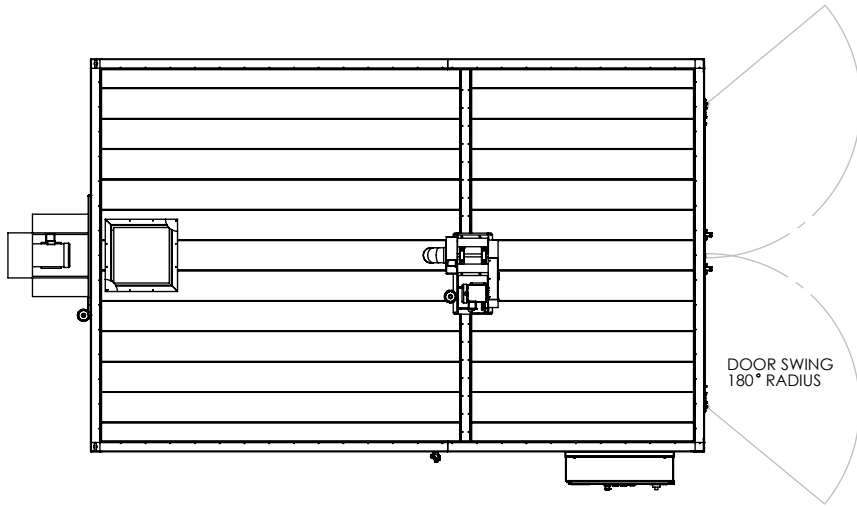

PLAN VIEW

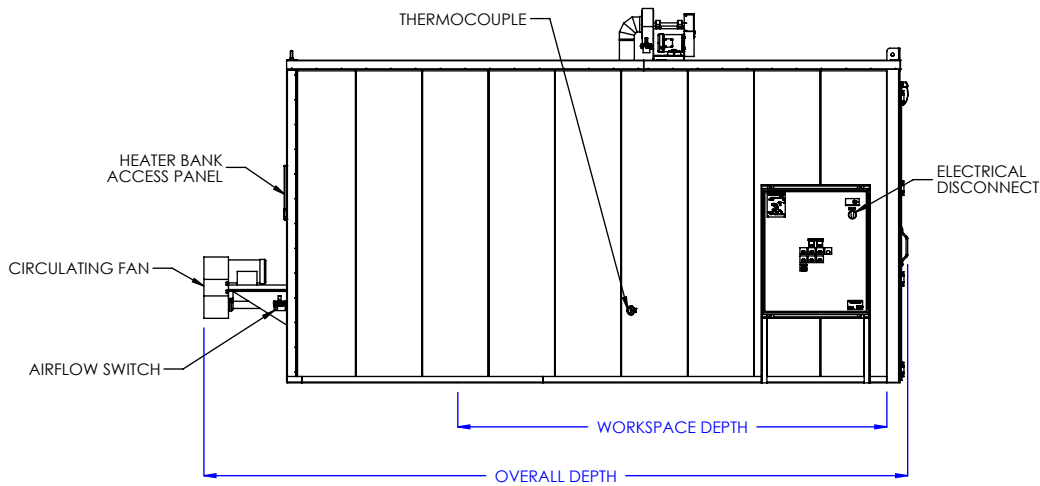

LEFT SIDE ELEVATION

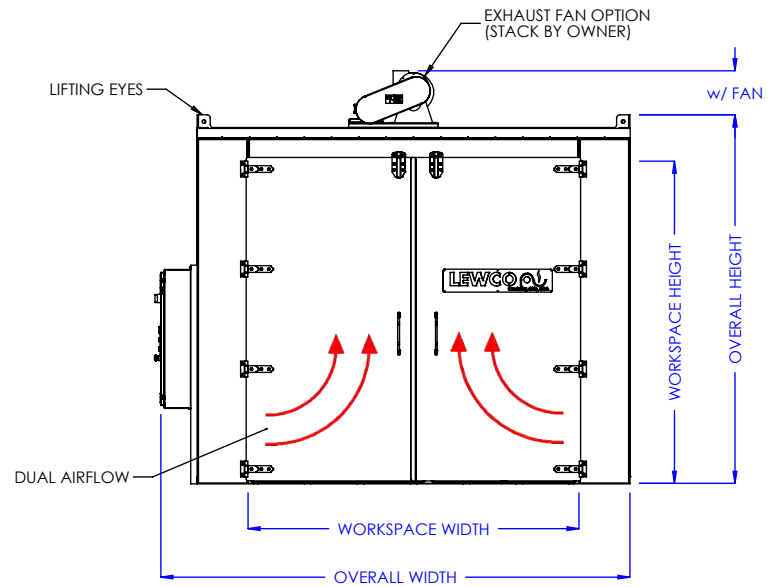

FRONT ELEVATION

MODEL: SWR05ED

DESCRIPTION: NORMAL DUTY WALK-IN OVEN, REAR MOUNT HEATER,
500° F, ELECTRIC, DUAL AIRFLOW

WARNING: OVENS PROCESSING FLAMMABLE VOLATILES OR COMBUSTIBLE MATERIALS ARE CLASSIFIED BY NFPA 86 AS "CLASS A" OVENS AND REQUIRE SPECIFIC SAFETY FEATURES. KNOW THE PROPERTIES OF THE MATERIALS BEING HEATED. EXPLOSION OR FIRE MAY RESULT FROM MISAPPLICATION.

LEWCO, INC. IS COMMITTED TO CONTINUOUS IMPROVEMENT AND RESERVES THE RIGHT TO CHANGE DESIGNS AND SPECIFICATIONS WITHOUT NOTICE.

THIS DRAWING MUST NOT BE COPIED, REPRODUCED OR USED FOR ANY PURPOSE WITHOUT THE WRITTEN CONSENT OF LEWCO, INC. ALL RIGHTS RESERVED.

DATE: 10/9/2017

REV. 001

PAGE: 1 of 1

LEWCO

706 LANE ST. SANDUSKY, OH 44870, U.S.A.