



Model: EWR06EH

Enhanced Duty Walk-In Oven

LEWCO Enhanced-Duty Batch Ovens are designed for critical applications, such as those in the advanced materials and aerospace industries. These models offer all of the same construction features as the Normal-Duty ovens; however the performance is "enhanced" by adding additional heat capacity and larger circulation fans. Enhanced-Duty ovens also guarantee a temperature uniformity of at least +/- 10°F. The EWR Series features a rear mounted heater box, which is ideal for installations with height restrictions. Each unit is fully assembled, wired, and tested prior to shipment. All LEWCO ovens are manufactured to meet the requirements of NFPA 86.

Operating Temperature

- 200°F – 650°F (93°C -343°C)

Heating Source & Capacity

- Electric, low watt density Incoloy® heaters provide years of trouble free service.
- Standard heater bank assemblies are installed in high velocity ductwork to maximize heat transfer.

Airflow Pattern

- Horizontal Airflow: Hot air is supplied from one side of the wall and pulled across horizontally to the opposite side wall.

General Construction

- 16 ga. aluminized steel interior
- 18 ga. cold rolled steel exterior
- Heat loss is minimized by a unique wall design featuring a welded inner shell and a completely isolated outer frame and covers.

Finish

- Blue or gray alkyd enamel
- Optional: Premium finish for corrosive environments

Doors

- Heavy-duty doors on an isolated door frame minimize heat loss. Wire core gaskets create a tight seal for efficient heating.
- Explosion venting latches
- Standard: Bi-parting swing doors
- Optional:
 - Vertical lift guillotine door
 - Door windows

Floor

- Standard: 12 ga. plate floor
- Optional:
 - 12 ga. plate floor with (1) pair inverted angle track
 - 12 ga. plate floor with (1) pair 6" wide wheel guides
 - Insulated (100 p.s.f. max.)
 - Insulated with (1) pair inverted angle track
 - Insulated with (1) pair 6" wide wheel guides
 - No floor

Input Voltage

- Standard 480/3/60
- Please consult factory for other available options.

Controls

- Single set-point temperature controller and redundant high-limit controller
- NEMA 12 enclosure with full voltage lockable disconnect switch
- Circulation fan(s) include air proving circuits that are electrically interlocked with the heating circuit.
- Controls are wired to NFPA 70 and 79 electrical standards, and meet the requirements of NFPA 86, Class B ovens.
- Optional:
 - Door Switch
 - Batch Timer
 - Ramp/ Soak controller
 - Data logger/ chart recorder
 - Zero speed switch for fans
 - Composite curing controls

Quality Assurance

- Each unit comes complete with a (1) year warranty and is fully assembled, wired, and tested prior to shipment.
- Unit manufactured under ISO 9001 Quality Certified System.



Industrial Batch Ovens

Model: EWR06EH

Model (NFPA Class B)	Overall Dimensions			Door Swing Radius	Workspace Dimensions			Heater Bank (kW)	Circulating Fan (CFM)	Motor (HP)	Air Changes per Minute	Exhaust Fan Capacity (CFM)	Exhaust Motor (HP)	Solvents per Batch (Gals.)	Ships Fully Assembled
	"W	"D	"H		"W	"D	"H								
EWR06EH-48-48-60	83	107	73	24"	48	48	60	45	2,000	1 1/2	25.00	N/A	N/A	0	Yes
EWR06EH-48-48-72	85	107	85	24"	48	48	72	54	2,500	2	26.04	N/A	N/A	0	Yes
EWR06EH-48-48-96	85	111	109	24"	48	48	96	63	3,000	3	27.34	N/A	N/A	0	Yes
EWR06EH-48-72-72	87	141	85	24"	48	72	72	63	4,000	3	27.78	N/A	N/A	0	Yes
EWR06EH-48-72-96	91	145	109	24"	48	72	96	72	5,000	3	26.04	N/A	N/A	0	Yes
EWR06EH-48-96-72	91	169	85	24"	48	96	72	72	5,000	3	26.04	N/A	N/A	0	Yes
EWR06EH-48-96-96	95	175	109	24"	48	96	96	81	7,000	5	27.34	N/A	N/A	0	Yes
EWR06EH-60-60-60	99	123	73	30"	60	60	60	54	3,500	3	28.00	N/A	N/A	0	Yes
EWR06EH-60-60-72	99	129	85	30"	60	60	72	63	4,000	3	26.67	N/A	N/A	0	Yes
EWR06EH-60-60-96	103	133	109	30"	60	60	96	72	5,000	3	25.00	N/A	N/A	0	Yes
EWR06EH-60-72-72	101	145	85	30"	60	72	72	63	4,500	3	25.00	N/A	N/A	0	Yes
EWR06EH-60-72-96	105	151	109	30"	60	72	96	81	6,000	3	25.00	N/A	N/A	0	Yes
EWR06EH-60-96-96	111	175	109	30"	60	96	96	90	8,000	5	25.00	N/A	N/A	0	Yes
EWR06EH-72-72-72	115	151	85	36"	72	72	72	72	5,500	3	25.46	N/A	N/A	0	Yes
EWR06EH-72-72-96	123	151	109	36"	72	72	96	81	8,000	5	27.78	N/A	N/A	0	Yes
EWR06EH-72-96-96	127	182	109	36"	72	96	96	81	10,000	7 1/2	26.04	N/A	N/A	0	Yes
EWR06EH-72-120-96	131	211	109	36"	72	120	96	108	12,000	7 1/2	25.00	N/A	N/A	0	Yes

NOTE: Sizes are approximate. LEWCO, Inc. reserves the right to change specifications without notice.



Industrial Batch Ovens

Model: EWR06EH

Model (NFPA Class A)	Overall Dimensions			Door Swing Radius	Workspace Dimensions			Heater Bank (kW)	Circulating Fan (CFM)	Motor (HP)	Air Changes per Minute	Exhaust Fan Capacity (CFM)	Exhaust Motor (HP)	Solvents per Batch (Gals.)	Ships Fully Assembled
	"W	"D	"H		"W	"D	"H								
EWR06EH-48-48-60	83	107	124	24"	48	48	60	54	2,000	1 1/2	25.00	62	1/4	0.04	Yes
EWR06EH-48-48-72	85	107	136	24"	48	48	72	63	2,500	2	26.04	62	1/4	0.04	Yes
EWR06EH-48-48-96	85	111	160	24"	48	48	96	72	3,000	3	27.34	62	1/4	0.04	No
EWR06EH-48-72-72	87	141	136	24"	48	72	72	72	4,000	3	27.78	62	1/4	0.04	Yes
EWR06EH-48-72-96	91	145	160	24"	48	72	96	81	5,000	3	26.04	62	1/4	0.04	No
EWR06EH-48-96-72	91	169	136	24"	48	96	72	81	5,000	3	26.04	62	1/4	0.04	Yes
EWR06EH-48-96-96	95	175	160	24"	48	96	96	90	7,000	5	27.34	62	1/4	0.04	Yes
EWR06EH-60-60-60	99	123	124	30"	60	60	60	63	3,500	3	28.00	62	1/4	0.04	No
EWR06EH-60-60-72	99	129	136	30"	60	60	72	72	4,000	3	26.67	62	1/4	0.04	Yes
EWR06EH-60-60-96	103	133	160	30"	60	60	96	81	5,000	3	25.00	62	1/4	0.04	No
EWR06EH-60-72-72	101	145	136	30"	60	72	72	72	4,500	3	25.00	62	1/4	0.04	Yes
EWR06EH-60-72-96	105	151	160	30"	60	72	96	90	6,000	3	25.00	62	1/4	0.04	No
EWR06EH-60-96-96	111	175	160	30"	60	96	96	117	8,000	5	25.00	100	1/4	0.07	No
EWR06EH-72-72-72	115	151	136	36"	72	72	72	81	5,500	3	25.46	62	1/4	0.04	Yes
EWR06EH-72-72-96	123	151	160	36"	72	72	96	90	8,000	5	27.78	62	1/4	0.04	No
EWR06EH-72-96-96	127	182	160	36"	72	96	96	117	10,000	7 1/2	26.04	100	1/4	0.07	No
EWR06EH-72-120-96	131	211	160	36"	72	120	96	153	12,000	7 1/2	25.00	100	1/4	0.07	No

NOTE: Sizes are approximate. LEWCO, Inc. reserves the right to change specifications without notice.

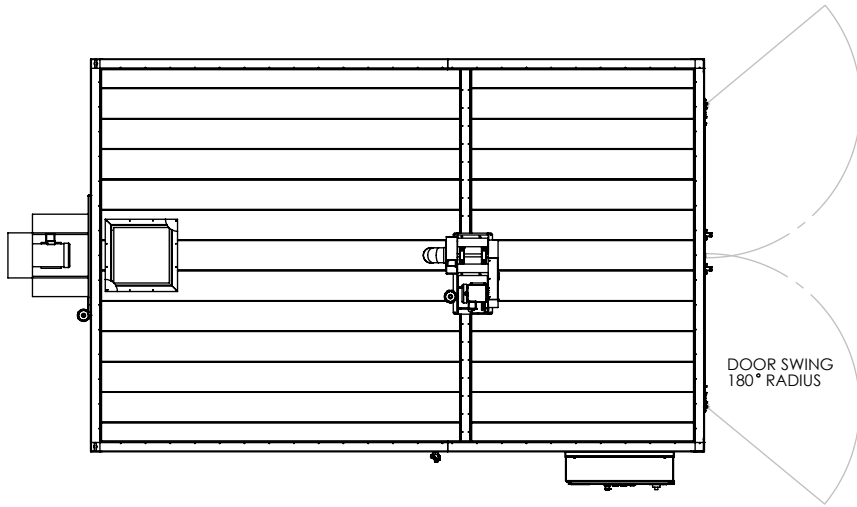

PLAN VIEW

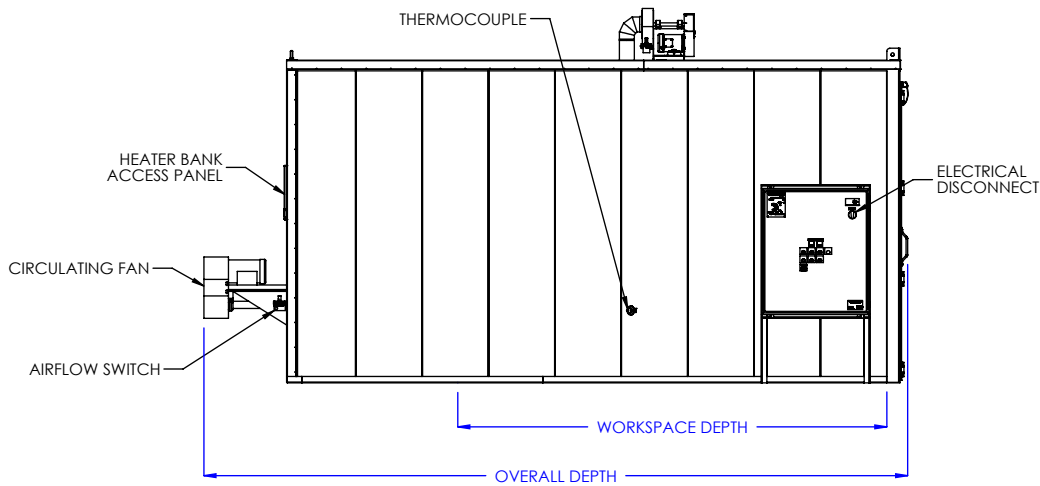

LEFT SIDE ELEVATION

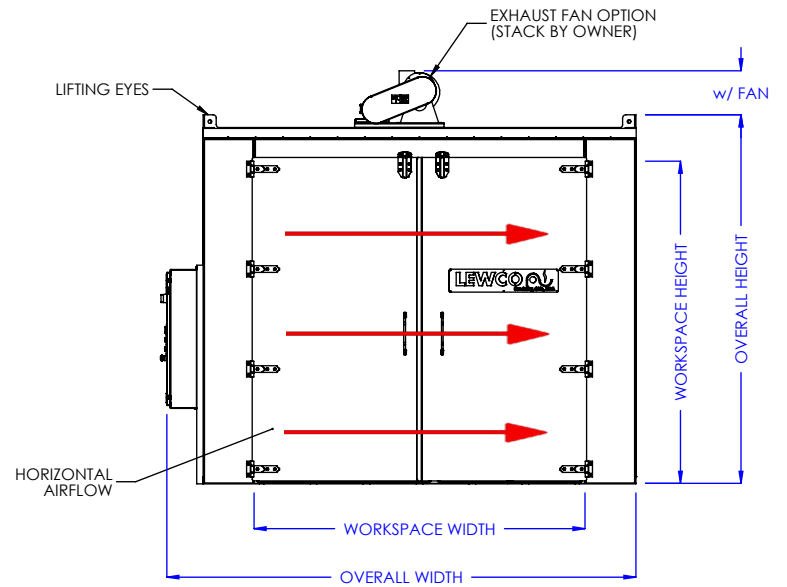

FRONT ELEVATION

MODEL: EWR06EH

DESCRIPTION: ENHANCED DUTY WALK-IN OVEN, REAR MOUNT HEATER, 650° F, ELECTRIC, HORIZONTAL AIRFLOW

WARNING: OVENS PROCESSING FLAMMABLE VOLATILES OR COMBUSTIBLE MATERIALS ARE CLASSIFIED BY NFPA 86 AS "CLASS A" OVENS AND REQUIRE SPECIFIC SAFETY FEATURES. KNOW THE PROPERTIES OF THE MATERIALS BEING HEATED. EXPLOSION OR FIRE MAY RESULT FROM MISAPPLICATION.

LEWCO, INC. IS COMMITTED TO CONTINUOUS IMPROVEMENT AND RESERVES THE RIGHT TO CHANGE DESIGNS AND SPECIFICATIONS WITHOUT NOTICE.

THIS DRAWING MUST NOT BE COPIED, REPRODUCED OR USED FOR ANY PURPOSE WITHOUT THE WRITTEN CONSENT OF LEWCO, INC. ALL RIGHTS RESERVED.

DATE: 10/9/2017

REV. 001

PAGE: 1 of 1

LEWCO

706 LANE ST. SANDUSKY, OH 44870, U.S.A.