



Owner's Manual

Constant Temperature Cabinets

MODEL: _____

SERIAL NUMBER: _____

TABLE OF CONTENTS

WARRANTY	1
INTRODUCTION	2
SAFETY SYMBOL DEFINITIONS.....	3
CONTENT DEFINITIONS.....	4
SECTION 1 – GENERAL INFORMATION	4
1-1 PRODUCT DESCRIPTION.....	4
1-2 SAFETY.....	4
1-3 PPE (PERSONAL PROTECTIVE EQUIPMENT).....	6
1-4 RECEIVING & HANDLING.....	7
1-4.1 RIGGING.....	7
1-4.2 RECEIVING INSPECTION.....	7
SECTION 2 – INSTALLATION	8
2-1 LOCATION.....	8
2-2 LEVELING & ANCHORING.....	8
2-3 DRAINAGE.....	9
2-4 EXHAUSTING & VENTING.....	9
2-5 ELECTRICAL INSTALLATION.....	9
SECTION 3 – OPERATION & USE	10
3-1 GENERAL OPERATING PROCEDURES.....	10
3-2 EMERGENCY SHUT-DOWN.....	10
SECTION 4 – MAINTENANCE	10
4-1 GENERAL.....	10
4-2 MAINTENANCE ITEMS.....	11
4-3 SERVICE & REPLACEMENT PARTS.....	11
SECTION 5 – TROUBLESHOOTING	12
SECTION 6 – APPENDIX	13

LEWCO, Inc.

Warranty

Drum & Tote Heating Products

1. Unless separately agreed to otherwise, Warranty is for three (3) years, free from defects of faulty material or workmanship, effective from Buyer's receipt of goods and services.
2. Warranty does not include maintenance items (door gaskets, fan belts, thermocouples, etc.).
3. LEWCO, Inc. will replace or repair equipment proving defective in material or workmanship. Defective parts need to be shipped back to LEWCO, Inc. for inspection, at Buyers cost.
4. Failure due to abuse, overloading, maintenance neglect, exposure to corrosive or abrasive materials, operation under any degree of dampness, or improper use shall not be subject to this warranty.
5. Any modification to equipment or systems without LEWCO, Inc.'s written consent voids this warranty.
6. Standard warranty does not include labor to remove and/or install defective equipment.
7. If LEWCO, Inc.'s service is required for assistance on a warranty claim, labor will be charged at prevailing rate plus travel expenses.
8. LEWCO, Inc. shall not be liable for loss of profits, delays or expenses incurred by failure of said parts, whether incidental or consequential.
9. LEWCO, Inc. shall not be liable for failure of the goods to comply with federal, state or local laws.
10. LEWCO, Inc.'s warranty becomes null and void if payment in full is not received for goods and services.
11. See LEWCO, Inc.'s **GENERAL TERMS AND CONDITIONS** for additional warranty detail.



INTRODUCTION

Thank you for choosing LEWCO, Inc. for your industrial equipment needs. This manual has been prepared by LEWCO engineers for use in familiarizing personnel with the design, installation, operation and maintenance of your LEWCO Constant Temperature Cabinet. Information presented herein should be given careful consideration to assure safe, optimum performance of the equipment. This manual should always be accessible to the operators for quick reference.

This unit has been designed and manufactured in accordance with applicable National Codes and Standards in effect as of the date of manufacture. It is the responsibility of the end user to update equipment as necessary to comply with future code changes or revisions.

This manual should be used in conjunction with the drawing(s), data sheets, and component manufacturer's literature attached hereto that clarify specific features, installation, utility connections, operation, etc.

If you have any questions regarding this manual or the use of your LEWCO Constant Temperature Cabinet, please contact our Industrial Oven department by phone at (419) 502-2780 or by email at ovensales@lewcoinc.com.

NOTE: The information in this manual is subject to change without notice and does not represent an obligation on the part of LEWCO, Inc. LEWCO does not assume any responsibility for any errors that may appear in this manual and under no circumstances will LEWCO be held liable for technical or editorial omissions made herein, nor for direct, indirect, special, incidental, or consequential damages resulting from the use or defect of this manual.



NOTICE: No installation or operation of this equipment should take place until this manual has been studied and understood by the person(s) responsible.

Copyright © 2016 by LEWCO, Inc.

All rights reserved. Reproduction or copying of this manual by any means, electronic or mechanical, including photocopying, recording, or information storage and retrieval systems is not permitted without the written permission of LEWCO, Inc.

Manual Specific Safety Symbol Definitions	
	Safety Instruction where an electrical hazard is involved.
	Safety instruction where non-compliance would affect safety.
	Safety instruction where non-compliance could potentially cause an explosion.
	Safety instruction where non-compliance could potentially cause a fire.
	Safety instruction relating to safe operation of the equipment (ATTENTION).
	Safety instruction where non-compliance could potentially result in a pinch point or a description of a known existing pinch point.
	Safety instruction where non-compliance could potentially result in a pinch point or a description of a known existing pinch point.
	Indicates a hazardous situation which, if not avoided, will result in death or serious injury. The signal word "DANGER" is to be limited to the most extreme situations. DANGER [signs] should not be used for property damage hazards unless personal injury risk appropriate to these levels is also involved.
	Indicates a hazardous situation which, if not avoided, could result in death or serious injury. WARNING [signs] should not be used for property damage hazards unless personal injury risk appropriate to this level is also involved.
	Indicates a hazardous situation which, if not avoided, could result in minor or moderate injury. CAUTION [signs] without a safety alert symbol may be used to alert against unsafe practices that can result in property damage only.
	Is used to describe preferred to address practices not related to personal injury.
Equipment Specific Safety Definitions	
	DANGER: Hazardous voltage will cause severe injury or death. LOCK OUT POWER before servicing.
	WARNING: Potential arc flash hazard.

CONTENT DEFINITIONS:

Arc Flash: An arc flash is a phenomenon where a flashover of electric current leaves its intended path and travels through the air from one conductor to another, or to ground. The results are often violent and when a human is in close proximity to the arc flash, serious injury and even death can occur.

Circulating Fan: The fan used to “move” the air around the workspace in order to more evenly distribute and more efficiently transfer the heat from the heat source to the material.

Safety Device: An instrument, a control or other equipment that acts, or initiates action, to cause the unit to revert to a safe condition in the event of equipment failure or other hazardous event.

Temperature Controller: A device that measures the temperature and automatically controls the input of heat into the unit.

SECTION 1 – GENERAL INFORMATION

1-1 PRODUCT DESCRIPTION

This cabinet is an electric system. Temperature is controlled by a self-contained PTAC (packaged terminal air conditioner) & Heat Pump unit, which provides heating and air conditioning to control cabinet temperature. The PTAC unit is typically mounted on the rear of the cabinet.

Process heating/ cooling applications involve a combination of time and temperature to achieve desired material properties. Although the process can sometimes be pre-determined based on heat transfer calculations and empirical data, these values are an engineering estimate at best. The precise combination of time and temperature, for a specific application, is best determined through actual trial use. By accurately monitoring time, temperature, and material properties closely, in a controlled environment, optimum process parameters can be safely and accurately determined.

1-2 SAFETY







WARNING: Only properly trained and qualified operators may use this equipment. Improper use may cause equipment damage, injury or death. Control systems are designed to react to system and operator input. Be sure to understand the system reaction before making any system adjustments.



Typically, a Constant Temperature Cabinet is purchased for a specific application. If the application for this equipment has changed, or you have reason to doubt the adequacy of the equipment for the application, consult your LEWCO, Inc. representative for proper use.





All standard LEWCO Cabinets are equipped with an interior door release mechanism. This will allow anyone trapped inside the cabinet to escape, simply by unscrewing the handle shown in *Figure 1*. All personnel should be aware of this safety device.



Figure 1: Door Release

 <h2 style="margin: 0;">DANGER</h2>	
 	<ul style="list-style-type: none"> Explosion or fire may result from misapplication of this equipment. Know the properties of the materials you are putting into the cabinet and be sure they can be heated safely at elevated temperature. Applications that may introduce flammable solvents or combustible materials into the cabinet require special nonstandard safety features. The National Fire Protection Agency (NFPA) designates these as “Class A” Ovens. Materials with auto-ignition temperatures below the cabinet operating temperature should never be introduced into the cabinet.
	<ul style="list-style-type: none"> Disconnect and lockout electrical power and all other sources of energy before performing maintenance. Know where arc flash is possible and take proper precautions. When PTAC unit is in STOP position, there is still voltage to the electrical controls.
	<ul style="list-style-type: none"> Be sure any fan shafts have stopped rotating. Keep body, hands and foreign objects away from the inlet and outlet, and the other moving parts of the fan such as shafts, belts and pulleys.

 <h2 style="margin: 0;">WARNING</h2>	
	<ul style="list-style-type: none"> Refrigeration system under high pressure; do not puncture, heat, expose to flame, or incinerate PTAC (packaged terminal air conditioner & heat pump) unit.

 <h2 style="margin: 0;">CAUTION</h2>	
	<ul style="list-style-type: none"> Do not leave the unit in operation unattended. Property damage or injury to personnel may result. Maintain cleanliness inside and around the unit. Plenums and ducts may be subjected to a build-up of flammable deposits, fluid, or combustible debris that may be fire hazards.
	<ul style="list-style-type: none"> Use caution when opening doors to avoid breathing air from inside the unit. Do not breathe air from exhaust vent. This equipment is to be operated by trained personnel only. When heating materials that generate hazardous vapors, venting or exhausting of the unit is required. This equipment may create a confined space hazard. The user is responsible for analyzing the installation in order to make a determination, posting warnings and complying with applicable OSHA standards pertaining to confined space hazards. Do not operate fans without belt & bearing guards in place as bodily injury may result.
	<ul style="list-style-type: none"> Pinch points may exist at door(s). Keep hands and arms clear.

To reduce the possibility of injury to personnel operating, or in the vicinity of the unit, warning signs are posted at potential hazard points on the equipment. Examine the equipment and become familiar with potential hazard areas. Instruct all personnel to be aware of these areas and to heed all posted caution and warning signs.

After complete installation of the equipment, a safety study should be made of the application and additional guards and warnings should be installed and posted as necessary. Any code requirements are the responsibility of the user and not that of LEWCO, Inc. Violation of the above safety rules hereby removes all product liability claims from LEWCO, Inc.



NOTICE: It is the responsibility of the owner to comply with all safety standards, including OSHA and other Federal, State, and Local codes or regulations.

1-3 PPE (PERSONAL PROTECTIVE EQUIPMENT)

PPE (Personal Protective Equipment) required will be site and process specific. LEWCO, Inc. recommends conducting a detailed study of your installation and process to determine what PPE will be required for safe operation.

Hearing Protection: According to OSHA protection against the effects of noise exposure shall be provided when the sound levels exceed those determined as unsafe.

Safety Glasses: It is never recommended to enter the workspace with the circulating fan(s) running. However, if anyone must do so for any reason, safety glasses **MUST** be worn.

Steel Toe Boots (Metatarsals): Nothing inherent to this unit or its process should require foot protection aside from the loading and unloading of the material from the cabinet. Use proper plant safety considerations for material handling and PPE.

Gloves/Sleeves: If unloading hot material always wear high temperature gloves. If the material being loaded/unloaded is sharp, protective gloves should be worn.

Temperature/Flame Resistant Clothing: If the material is being unloaded hot, wear the appropriate clothing. This may include temperature resistant sleeves, jacket, pants or any combination of the aforementioned clothing.

Fall Protection: Normal operation of the unit will not require the operator to be on top of the equipment, however, some maintenance and troubleshooting may require personnel to be more than 6' off of the ground. If this is the case, proper fall protection must be used at all times.

1- 4 RECEIVING & HANDLING

Special care must be taken in handling this equipment due to its configuration, size, and weight. Most LEWCO cabinets are equipped with either fork pockets or lifting lugs, also known as lifting eyes. Models not equipped with lifting lugs or fork pockets (typically low profile models), can be moved via fork truck. To do this, open the doors and place forks underneath the roof of the unit, then lift. It is recommended that wood blocks or another non-marring material be inserted between the forks and the inside roof of the unit to prevent scratches or dents.

1- 4.1 RIGGING

When applicable, lifting lugs are provided at the top (4) corners of the unit. It is important to note that rigging cables or chains must not exceed a maximum angle of 10 degrees from vertical (see *Figure 2*). Use a spreader beam, or rigging of adequate length, to avoid damage to the equipment. Please refer to any assembly drawings for specific assembly and rigging instructions.

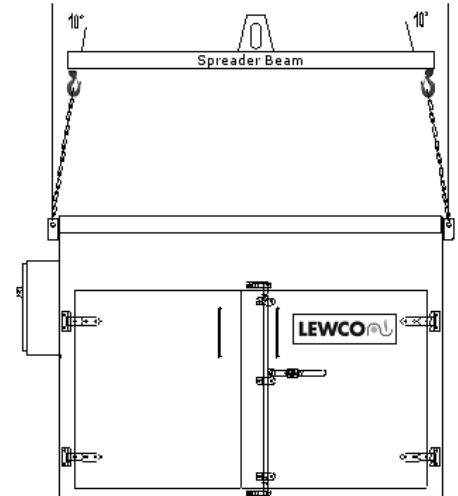

Figure 2: Typical Rigging

1- 4.2 RECEIVING INSPECTION

Before removing banding and/or packaging materials, locate the packing slip. The packing slip contains a complete list of all materials shipped. Verify completeness of shipment against packing slip for each item. Inspect each item for damage that could have occurred during shipment.

On collect shipments, all claims for shipping damage must be made against the carrier by the purchaser. All shipments received “short or damaged” must be noted on the freight bill when signed by the receiver. The delivering carrier may deny a claim if not noted on the freight bill when signed by the receiver. However, if damage is concealed, and not discovered at the time of delivery, an inspection must be requested to the delivering carrier within 24 hours.

All claims for shortages against the packing list must be made against LEWCO, Inc. within 48 hours of receipt. Claims for replacement materials and equipment submitted after 48 hours of receipt will be invoiced to the customer.

SECTION 2 – INSTALLATION

Prior to installation, the owner should consult their insurance underwriters for recommendations and requirements regarding the installation and maintenance of this equipment.

2-1 LOCATION

Constant Temperature Cabinets are designed for indoor use only, unless the outdoor service package option is specified on the purchase order.

NOTE: Installation in unheated areas or areas without climate control may result in non-uniform temperatures or the inability to attain desired temperature. Condensation may also occur, which could damage the unit.

Due to the inherent hazards of this equipment, including the possibility of fire, property damage, and personal injury, selection of the unit's location must be carefully planned. In planning the location, consideration should be given to the following:

PERSONNEL SAFETY:



CAUTION: Avoid installations near exits or main aisles to minimize the risk to personnel associated with fire, explosion, or asphyxiation.

FLOOR: The cabinet should always be placed on a non-combustible surface with adequate load capacity. Consideration must be given to the weight of the cabinet, weight of the materials being processed, and the weight of any carts or fixtures.

PROXIMITY: Do not locate the cabinet against walls. A minimum air space of 36" should be kept between PTAC unit and walls or other major obstructions. For minor obstructions, such as poles and railings, a minimum air space of 12" must be maintained. Always ensure there is adequate distance for the door(s) to fully open. Consider maintenance access to controls, thermocouples, filters, and PTAC unit.



DANGER: Consideration should be given to the proximity of adjacent storage areas, particularly those that may include flammable liquids or gasses, or combustible materials as these vapors or materials may be drawn into the cabinet through circulating fan(s) or exhaust vent(s).

VENTILATION: The unit should be located so that air circulation around the equipment is not restricted. Do not block fresh air inlets or exhaust outlets. Particular consideration should also be given to all fans and motors. Avoid installations in basements or other areas with restricted fresh air.

2-2 LEVELING & ANCHORING

Set the cabinet on a level, non-combustible, surface. The unit should be leveled both side to side and front to back in reference to the inside grating or floor of the unit. If necessary, shim or grout the unit. Leveling is important to insure proper door alignment and swing. Anchor the cabinet with expansion anchors through the holes provided. Use anchors 1/8" smaller than the holes provided.

2-3 DRAINAGE

Due to condensation generated by the PTAC unit, a drainage kit must be installed. Improper draining could create slip hazards. Refer to the supplied component literature for detailed instructions.

2-4 EXHAUSTING & VENTING

If the cabinet was purchased with a vent option, a number of acceptable connection methods are available to exhaust the unit. To avoid exposure to operating personnel, the owner must determine a suitable vent/exhaust method based on the toxicity, amount, and weight of vapor being generated. Consult local stack emission restrictions if the vapors being exhausted may affect air quality.

Connection to an existing plant fume removal system is the preferred vent connection method. The vent connection is 5" OD duct. A sheet metal slip-on, draw band connection is adequate. At installations where a plant exhaust system is unavailable, a "chimney" connection is also an acceptable method to remove lower concentrations of lighter vapors. An outdoor vertical section of duct, of adequate height to produce a chimney effect, has proven successful in many applications. A rain cap is required on outdoor stacks.

If applicable, use the blast gate provided to attain an optimum combination of vapor exhaust and unit temperature. This may be especially important when trying to attain relative operating temperatures.

2-5 ELECTRICAL INSTALLATION

Electrical connections should be made by a qualified electrician in accordance with NFPA 70, "National Electric Code." The installation must also meet the requirements of any applicable state and local codes.

All standard model cabinets are shipped factory wired complete. Connect power to the main disconnect switch using wire of adequate size to carry the full load current rating of this device. Secure all connections and ground the unit adequately. In most cases, a grounding lug is provided in the main control panel.

After wiring is complete, make a final check of all electrical connections to confirm that none have vibrated loose in transit from LEWCO. Tight power connections will reduce component failure due to poor contact.

If a circulating fan(s) option was included, check the fan(s) for proper rotation direction. An arrow on the fans housing indicates proper direction of rotation. The installer should also verify that the fan drive components (belt and pulleys) have not become misaligned or loose during shipment. Excessive noise and/or vibration may be the result of loose or misaligned drive components. As standard, proper rotation produces an airflow pattern that draws air into the fan inlet at the bottom of the cabinet and discharges air back into the top of the cabinet.

SECTION 3 – OPERATION & USE

3-1 GENERAL OPERATING PROCEDURES

Operators must be adequately trained in start-up and shut-down procedures. It is the owner's responsibility to insure that operators are also familiar with the cabinet's intended application and aware of the design limitations of the equipment in order to avoid misapplication. Do not leave this equipment in operation unattended.

Operating instructions specific to this equipment are detailed in the **Appendix, section 6-1**. It is recommended that the owner post a copy of operating instructions at the unit.

3-2 EMERGENCY SHUT DOWN

Your LEWCO, Inc. Constant Temperature Cabinet has been engineered and built to the highest industry standards. In the unlikely event of equipment malfunction or emergency, the following steps should be followed:

1. Turn off the electrical disconnect providing power to the unit.
2. Depending on the severity of the issue, evacuate or restrict access to the area until the issue has been resolved.

SECTION 4 - MAINTENANCE

4-1 GENERAL

Industry experience indicates that improper maintenance is another leading cause of equipment failure, often resulting in property damage or injury to personnel. To maximize service life and assure safe, optimum, performance of this equipment, the owner should develop and follow a preventative maintenance program.



WARNING: Do not attempt any maintenance on this equipment unless all sources of energy are disconnected and locked out. Before performing work on fan(s), special caution must also be taken to secure the wheel.

4-2 MAINTENANCE ITEMS

This list of maintenance items is a general overview of the minimum items that may need to be addressed on your LEWCO Constant Temperature Cabinet. The actual list may vary depending on the specific equipment provided. The owner should make the final determination on maintenance intervals and tasks to be performed while considering the working environment. Please review the supplied component literature for further detail and potential additional maintenance items.

Maintenance Items	Frequency			
	Daily	Monthly	6 Months	Annual
Inspect the cabinet workspace, and if applicable, the circulating fan(s), ductwork, and vent stack for accumulation of foreign matter. Clean as required.	▪			
Inspect cabinet door(s) for gasket wear and tear. Replace as needed.	▪			
Clean PTAC air filters. Replace as necessary.		▪		
Inspect electrical connections and components for tightness and signs of wear.		▪		
Inspect circulating fan(s). Tighten set-screws between bearings and shaft, and also wheel set-screws on all circulating fans.		▪		
Check for belt tension and wear on belt driven fans. Replace belt as needed.		▪		
Lubricate circulation fan(s) shaft bearings every 500 hours of operation.		▪		
Inspect PTAC coils and base pan. Clean as necessary.			▪	
Fan motors should be lubricated at least every 5,500 hours of service.			▪	
Inspect PTAC wall sleeve and drainage system. Clean drain as necessary. Confirm a tight seal around the wall sleeve attached to the cabinet and reseal as needed.				▪
Conduct operator training course or refresher course				▪

NOTE: Air streams containing particulate or chemicals can cause abrasion or corrosion of fan parts. When such wear is discovered, a decision must be made as to whether to rebalance or replace the wheel.

4-3 SERVICE & REPLACEMENT PARTS

For service or replacements parts, please contact LEWCO's Customer Service Department by calling 419-625-4014, ext. 4012 or emailing customerservice@lewcoinc.com. Please be prepared to provide both your MODEL and SERIAL NUMBER when ordering.

SECTION 5 – TROUBLESHOOTING

PROBLEM	CAUSE(S)	SOLUTION
Unit does not operate	Thermostat is satisfied	Raise/Lower temperature setting.
	LCDI power cord is unplugged.	Plug into a properly grounded 3 prong receptacle. See "Electrical Rating Tables" on page 13 of PTAC manual for the proper receptacle type for your unit.
	LCDI power cord has tripped.	Press and release RESET (listen for click; Reset button latches and remains in) to resume operation.
	Circuit breaker has tripped.	Reset the circuit breaker.
	Supply circuit fuse has blown.	Replace the fuse.
	Local power failure.	Unit will resume normal operation once power has been restored.
Unit trips circuit breaker or blows fuses	Other appliances being used on same circuit.	The unit requires a single outlet circuit, not shared with other appliances.
	An extension cord is being used.	Do NOT use an extension cord with this unit.
	Circuit breaker or time-delay fuse isn't of the proper rating.	Replace circuit breaker or time-delay fuse for the proper rating.
PTAC unit does not cool/ heat the cabinet sufficiently, or cycles on and off to frequent	The return/discharge air grille is blocked.	Ensure that the return and/or discharge air paths are not blocked by curtains, blinds, furniture, etc.
	The temperature is not set at a cool or warm enough setting.	Adjust the temperature control to a cooler or warmer setting as necessary.
	The filter is dirty or obstructed.	Clean the filter, (See maintenance items) or remove obstruction.
	The indoor coil or outdoor coil is dirty or obstructed.	Clean the coils, (See maintenance items) or remove obstruction
	The temperature of the cabinet is extremely hot.	Allow additional time too cool hot cabinet.
	The external temperature is below 60° F.	Do not operate unit in cooling mode when external temperature is below 60° F. The unit will not cool properly and damage may result.
	The digital control is set to fan cycling mode.	Since the fan does not circulate the cabinet air continuously at this setting, the cabinet air does not mix as well and hot (or cold) spots may result. Using the continuous fan setting is recommended.
	Cabinet doors are open.	Close cabinet doors.
Unit runs too much	Excessive heat load or warmer climates	If the products being loaded into the cabinet are hot, or the cabinet itself is subject to warmer climates, the unit needs to run longer to remove additional heat.

**Consult component literature for additional troubleshooting help.*

SECTION 6 – APPENDIX

The Appendix of this manual contains installation and operation specific information. If your installation requires non-standard information requirements, such as calibration certifications or equipment specific data, it will be found at the end of this section.

6-1 OPERATING INSTRUCTIONS

Also included with this manual:

- 1. DRAWINGS**
- 2. ELECTRICAL SCHEMATICS**
- 3. COMPONENT LITERATURE**