

DRIVE MOUNTED HIGH

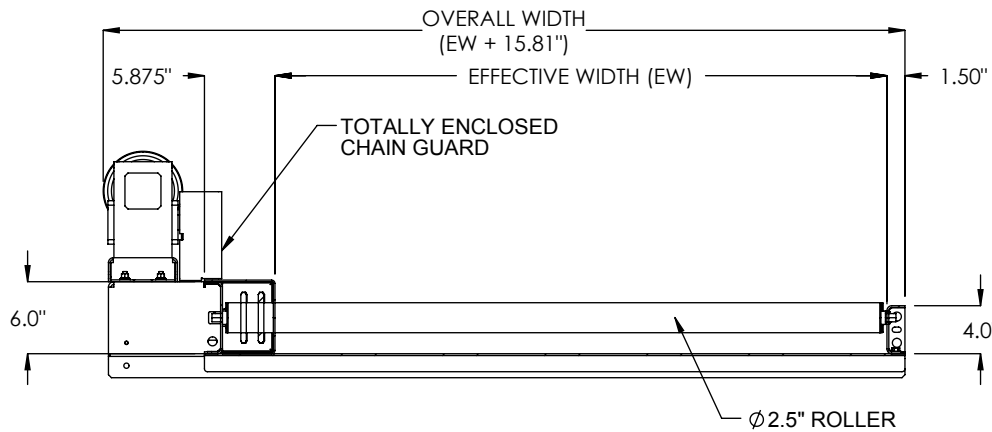

**SECTION A-A
DRIVE MOUNTED HIGH**

SPECIFICATIONS

EFFECTIVE WIDTH: 12" - 60"

BEGINNING ELEVATION: 7" - 120"

DEGREES: 45°, 90°

ENDING ELEVATION: 7" - 120"

SPEED: 10 - 120 FPM

ROLLERS: CDRC25 Roller - 2.50" diameter, 11ga wall tube. CDRC26 Roller - 2.625" diameter, 7ga wall tube. All rollers with 11/16" hex cold rolled steel axles, spring retained. Standard bearings are precision, grease packed bearings.

DRIVE: Standard drive is mounted high near center of conveyor length on chain box side. Optional drives include drive mounted low or drive mounted below and within, near center.

FRAME: Standard frame includes 6" channel on chain box side and 4" channel on opposite side with roller set high in frame. Optional frame options include 6" channel on opposite side with roller set low in the frame, or structural 6@8.2# & 4@5.4# with rollers set high, or structural 6@8.2# both sides with roller set low.

MOTOR: 1/2 HP through 2 HP. Energy efficient and inverter duty motors also available. Voltages include 120/1/60, 230/3/60, 460/3/60 and 575/3/60 & DC Voltage.

ROLLER COVERS: Standard roller surface is carbon steel. Optional roller covers for 2.5" rollers includes galvanized roller tube, polyurethane roller sleeves, Ultrax accumulation sleeves.

SUPPORT CENTERS: Standard supports are floor supports on 5' center.

FRAME FINISH: Standard finish is OSHA safety blue powder. Optional colors include green, beige, gray, orange, black and yellow.

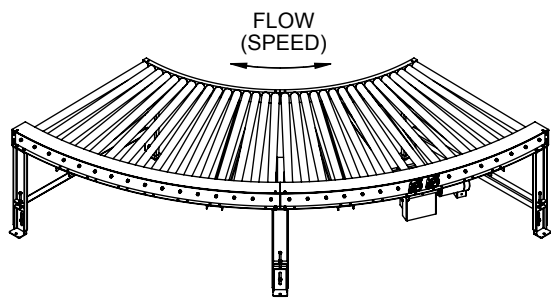

DRIVE MOUNTED BELOW AND WITHIN

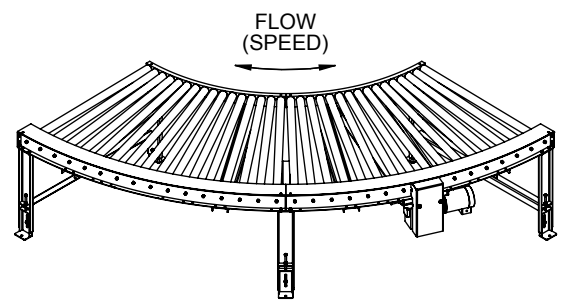

DRIVE MOUNTED LOW

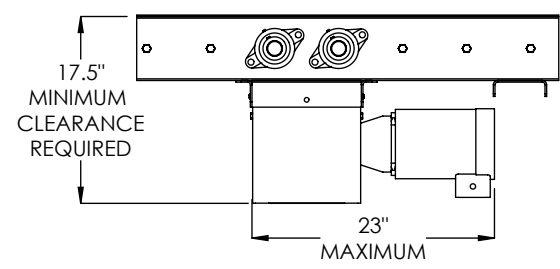

DRIVE OPTION MOUNTED BELOW AND WITHIN

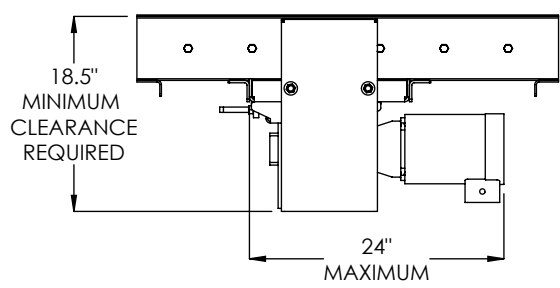

DRIVE OPTION MOUNTED LOW

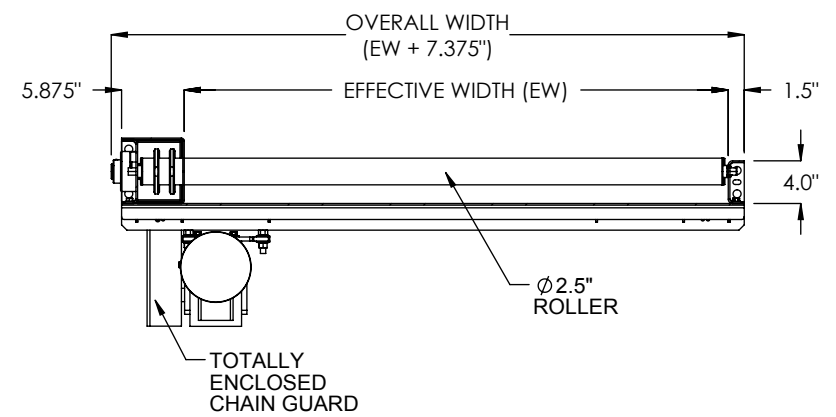

DRIVE MOUNTED BELOW AND WITHIN END VIEW

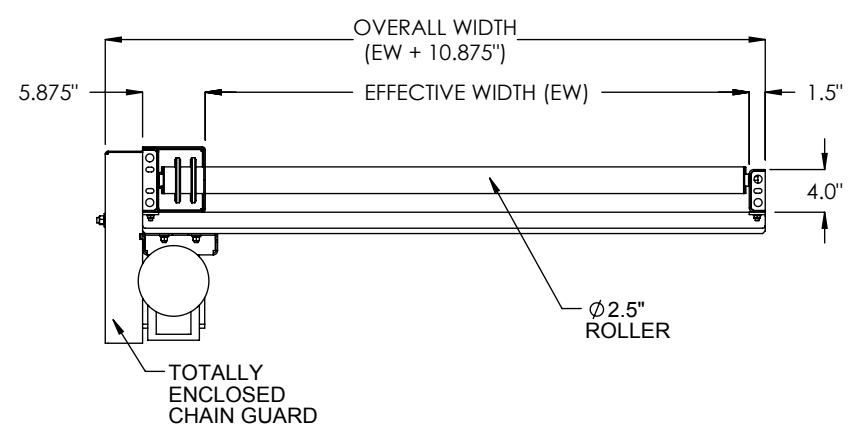

DRIVE MOUNTED LOW END VIEW

FRAME OPTIONS:

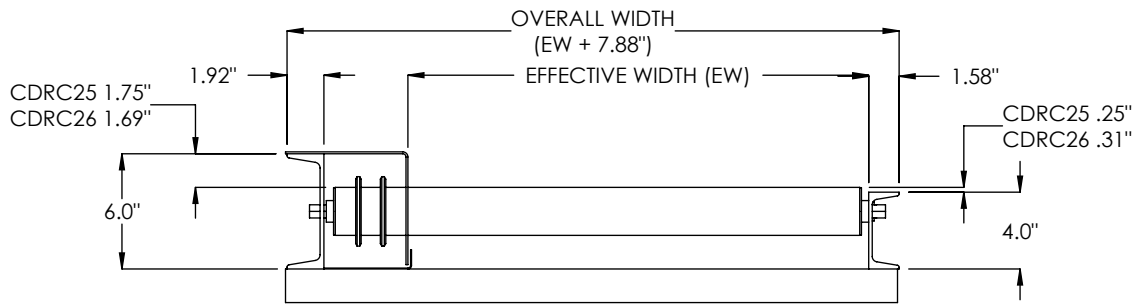

FC08 CHANNEL, 6@8.2# & 4@5.4#

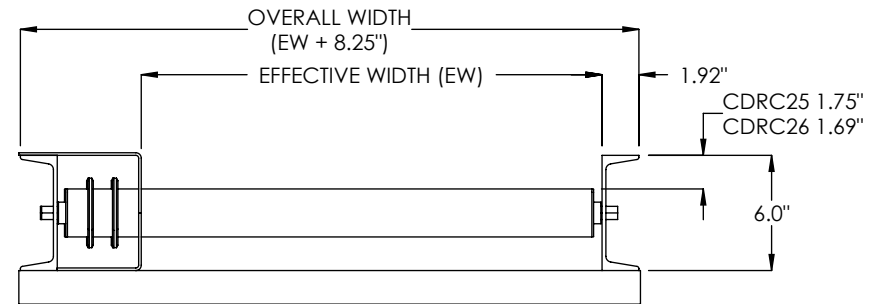

FC17 CHANNEL, 6@8.2#

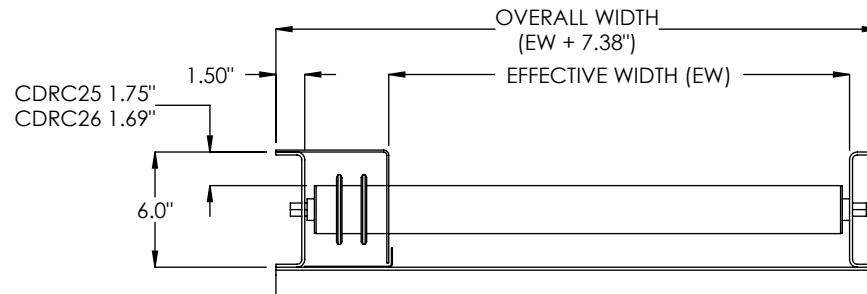

FC22 CHANNEL, 6" x 1-1/2" x 8ga