

LOAD CAPACITY: 3000 LB. MAXIMUM LOAD PER SUPPORT.

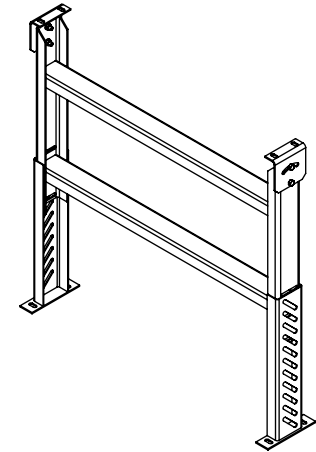
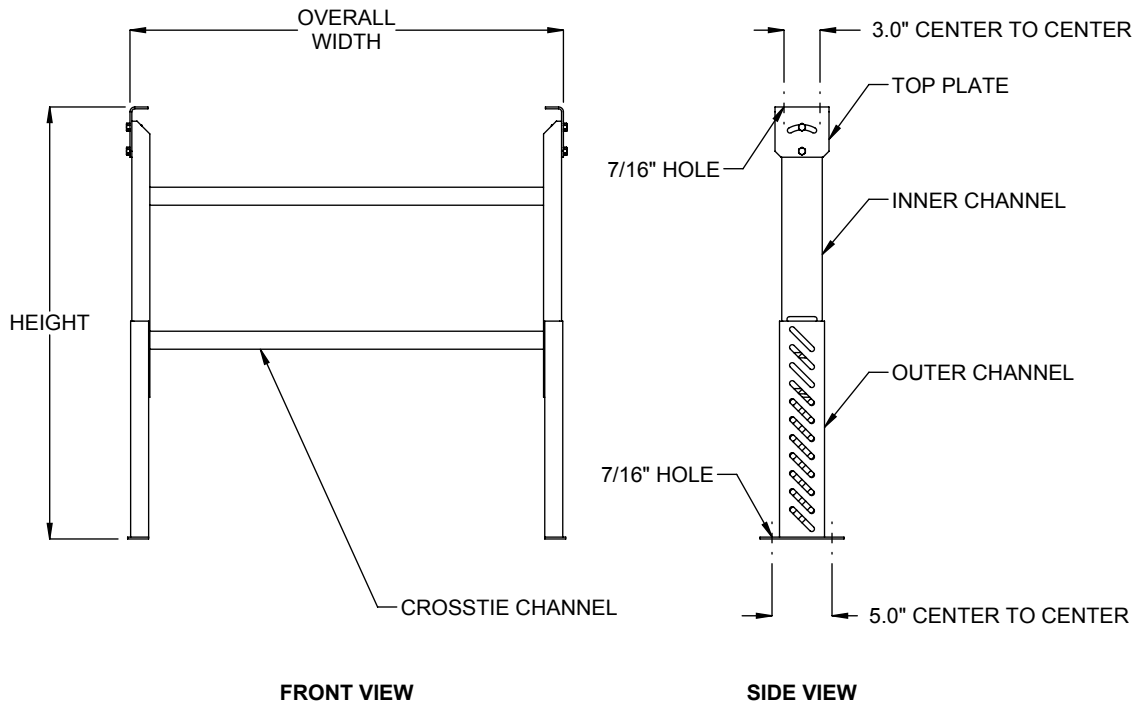

**SPH: HEIGHT RANGE**

MODEL	MIN.	MAX.	MODEL	MIN.	MAX.	MODEL	MIN.	MAX.
SPH8	6.00"	8.00"	SPH26	20.75"	26.75"	SPH104	87.75"	104.75"
SPH10	7.00"	10.00"	SPH33	22.75"	33.75"	SPH114	97.75"	114.75"
SPH12	8.50"	12.00"	SPH36	24.75"	36.50"	SPH117	100.75"	117.75"
SPH13	10.00"	13.00"	SPH46	31.75"	46.75"	SPH120	103.75"	120.75"
SPH14	12.75"	14.25"	SPH58	43.75"	58.75"	SPH126	109.75"	126.75"
SPH16	13.75"	16.75"	SPH70	55.75"	70.75"	SPH130	113.75"	130.75"
SPH18	14.75"	18.75"	SPH82	82.75"	114.50"			
SPH22	16.75"	22.75"	SPH92	75.75"	92.75"			

**SPECIFICATIONS**

**OVERALL WIDTH:** 7" - 78"

**CONSTRUCTION:** Formed steel inner and outer channels, 8ga; Welded channel crosstie, 12ga; Base plate, 8ga.

**TOP PLATE:** Standard 8ga pivot top plate is available where adjustable pitch is required.

**FINISH:** Standard finish is OSHA safety blue powder. Optional colors include green, beige, gray, orange, black and yellow.

**Model:** SPH - Support, Heavy Duty

REV
0

