

LOAD CAPACITY: 6000 LB. MAXIMUM LOAD PER SUPPORT.

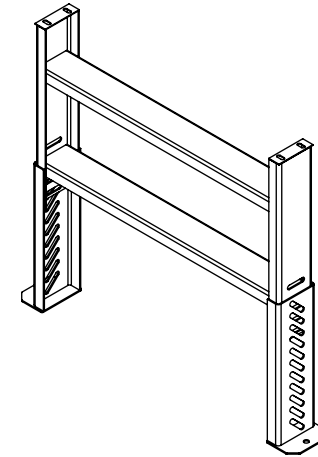
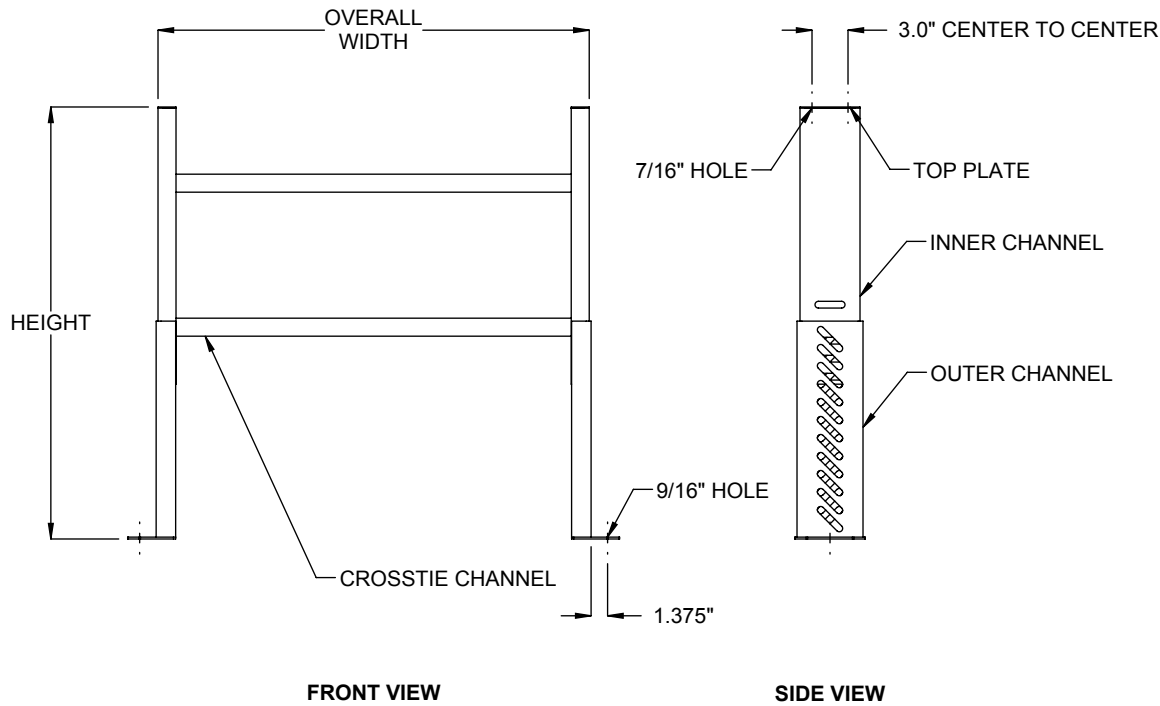

**SPHH: HEIGHT RANGE**

MODEL	MIN.	MAX.	MODEL	MIN.	MAX.	MODEL	MIN.	MAX.
SPHH9	6.50"	9.50"	SPHH26	20.75"	26.75"	SPHH92	75.75"	92.75"
SPHH11	8.50"	11.50"	SPHH33	22.75"	33.75"	SPHH104	87.75"	104.75"
SPHH13	10.50"	13.50"	SPHH36	24.75"	36.50"	SPHH114	97.75"	114.75"
SPHH14	12.75"	14.25"	SPHH46	31.75"	46.75"	SPHH117	100.75"	117.75"
SPHH16	13.75"	16.75"	SPHH58	43.75"	58.75"	SPHH120	103.75"	120.75"
SPHH18	14.75"	18.75"	SPHH70	55.75"	70.75"	SPHH126	109.75"	126.75"
SPHH22	16.75"	22.75"	SPHH82	82.75"	114.50"	SPHH130	113.75"	130.75"

**SPECIFICATIONS**

**OVERALL WIDTH:** 9" - 66"

**CONSTRUCTION:** Formed steel inner and outer channels, 8ga; Welded channel crosstie, 12ga; Base plate, 4ga.

**TOP PLATE:** Standard 8ga fixed top plate.

**FINISH:** Standard finish is OSHA safety blue powder. Optional colors include green, beige, gray, orange, black and yellow.

**Model:** SPHH – Support, Extra Heavy Duty

REV
0

