

LOAD CAPACITY: UP TO 4000 LBS. MAXIMUM LOAD PER SUPPORT.

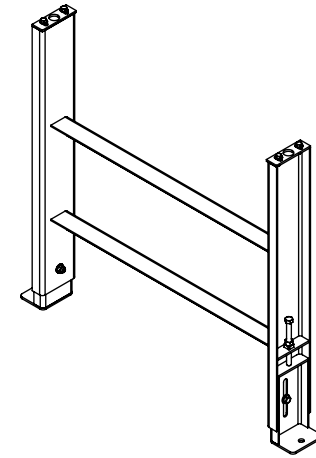
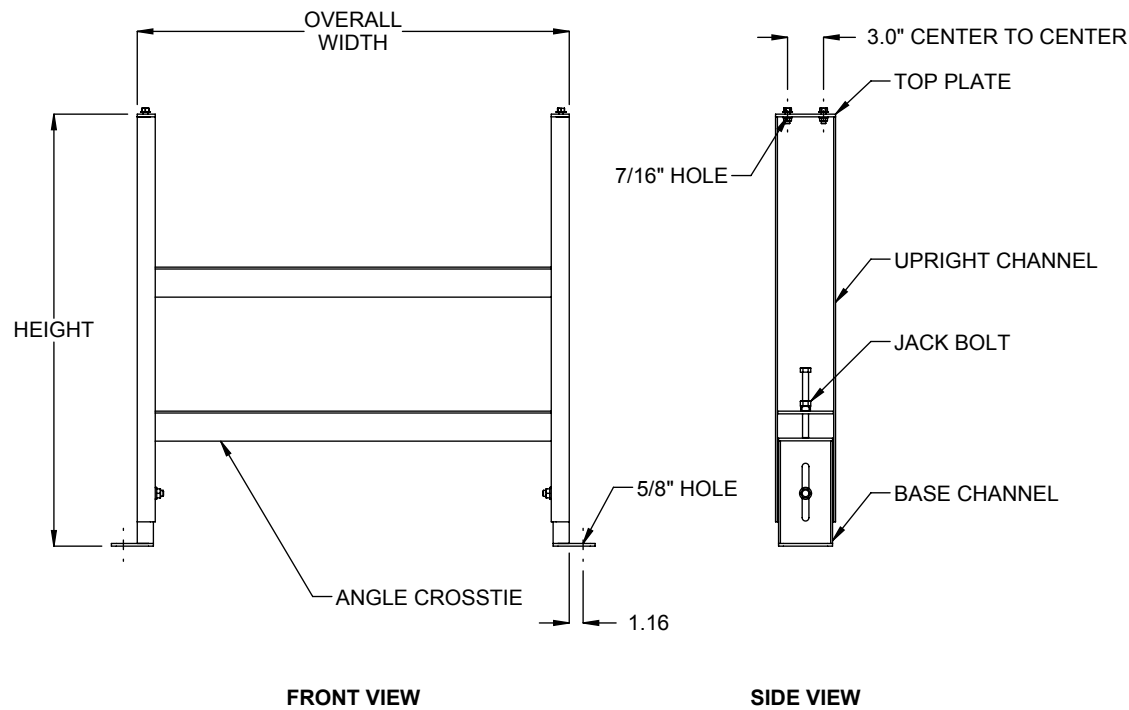

SPECIFICATIONS

OVERALL WIDTH: 9" - 93"

HEIGHT: 9" - 84"

HEIGHT ADJUSTMENT: +/- 1" from 9" up to 14" HEIGHT. +/- 2" for 14" and greater HEIGHT.

CONSTRUCTION: Formed 5" wide, 8ga upright channel and formed 4-1/2" wide, 8ga base channel. Welded angle crosstie, 8ga. Base plate, 4ga.

TOP PLATE: Standard 4ga fixed top plate.

FINISH: Standard finish is OSHA safety blue powder. Optional colors include green, beige, gray, orange, black and yellow.

Model: SPJ5, Support, 5" Formed Channel, Jack Bolt

REV
0

